



Střední průmyslová škola
strojní a stavební, Tábor

Š O L S K I  C E N T E R
Š K O F J A L O K A

ERASMUS +
SLOVENIA 2024

CNC and 3D Training

WHAT IS ERASMUS

+

-
- Program of the European Union that supports education
 - It provides financial resources for students exchanges





Střední průmyslová škola
strojní a stavební, Tábor

ABOUT US

- Martin Matějček
- Josef Kluzák
- Pavel Mazouch
- We are studying mechanical engineering



CZECH REPUBLIC

- Capital city : Prague
- Population : 10,9 mil.
- Area : 78 871 km²
- Official language : Czech

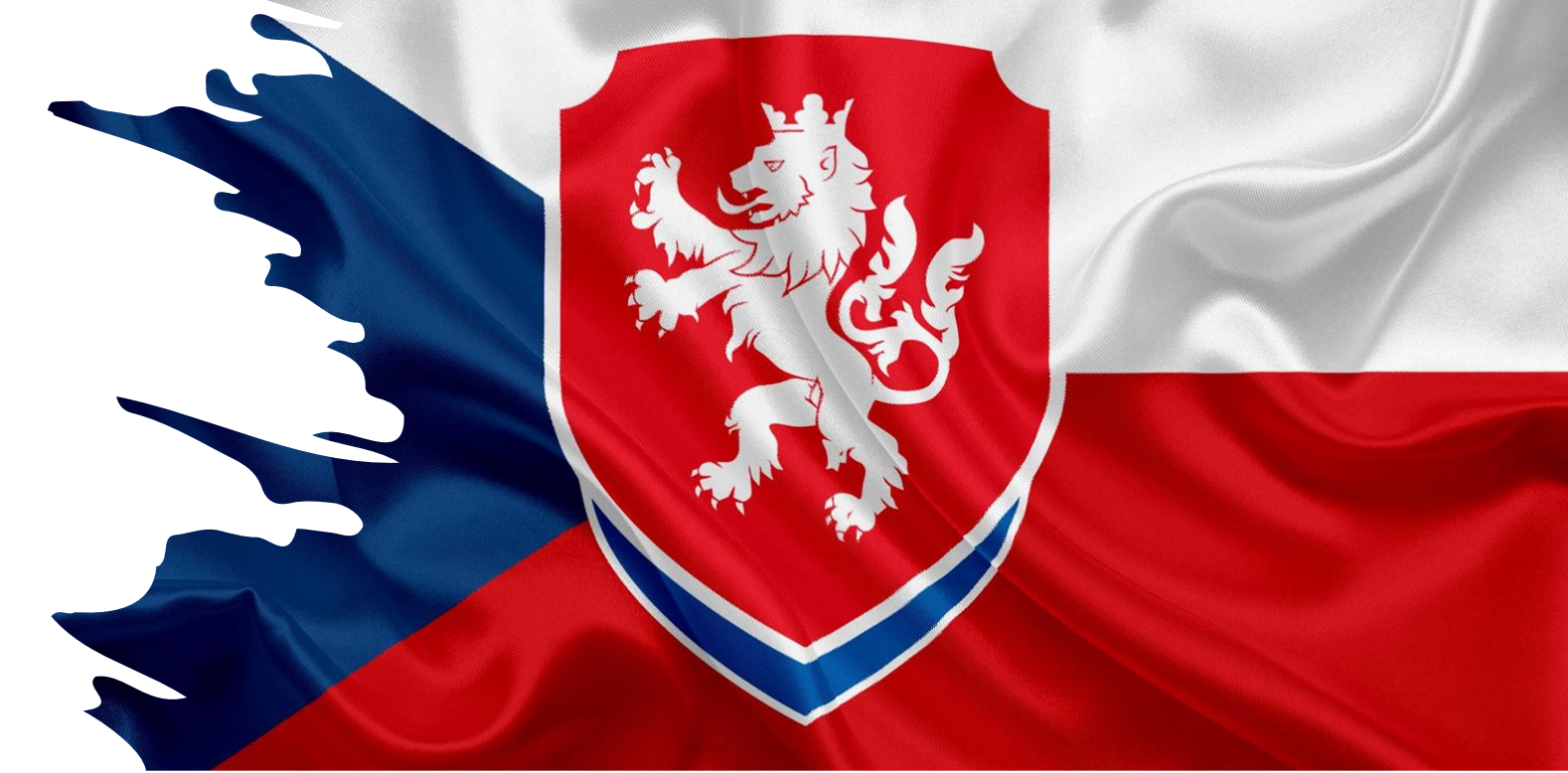

TÁBOR

- Founded : 1420
- Population :34 000
- Area : 62,22 km²



SECONDARY SCHOOL OF CIVIL AND MECHANICAL ENGINEERING TÁBOR

- Founded: 1952
- Technical lyceum
- Civil engineering
- Mechanical engineering
- Practical training



WHO WE ARE?



- Marián Kotrady
 - Dominik Tatarko
 - Dávid Švihura
-
- We are students of the Secondary Technical School in Spišská Nová Ves and we study the field technical lyceum and network technologies
 - We are in third grade

SLOVAKIA

- Capital city: Bratislava
- Population: 5,5 million people
- Area: 49 035 km²
- Official language: Slovak (Slovenčina)



Spišská Nová Ves

- Founded: 1268
- Population: 36,700 people
- Elevation: 430 m



STREDNÁ PRIEMYSELNÁ ŠKOLA TECHNICKÁ SNV

- Mechanical Engineering
- Mechatronics
- Information and Network Technologies
- Electrical Engineering Technical
- Lyceum Logistics



SPS
TECHNICKÁ
SPIŠSKÁ NOVÁ V

WHO WE ARE?

Name: Luka Vukmanić

Age: 17

Hobbies: playing accordion,
riding a motorcycle

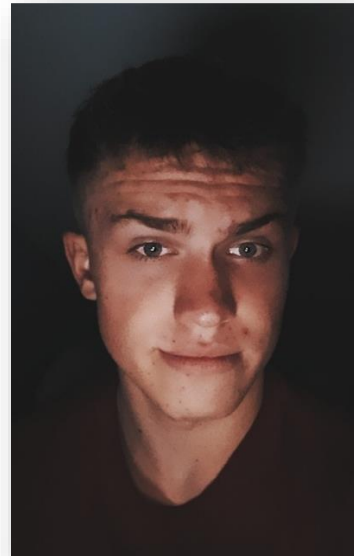

Name: David Mirt

Age: 18

Hobbies: reading, riding a
bicycle

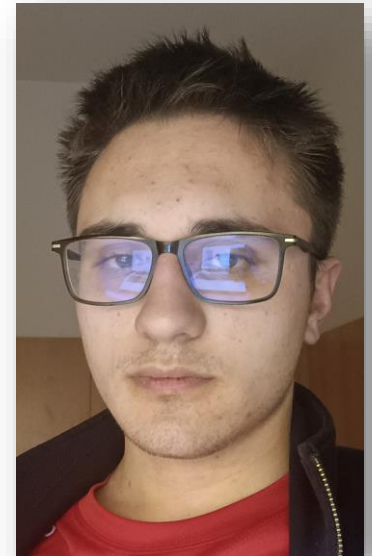

CROATIA

Capital city: Zagreb

Population: 3.8 million people

Area: 56.594 km²

Official language: Croatian
(Hrvatski)



SREDNJA ŠKOLA OROSLAVJE

Founded in 1973.

Secondary school with around 350
students

Our program: mechanical computer
technician





WHAT HAVE WE LEARNED ?



CAD TECHNOLOGIES

- Mentor: Mr. Matjaž Luznar
- PTC Creo 9
- Basic operations
- Assembling

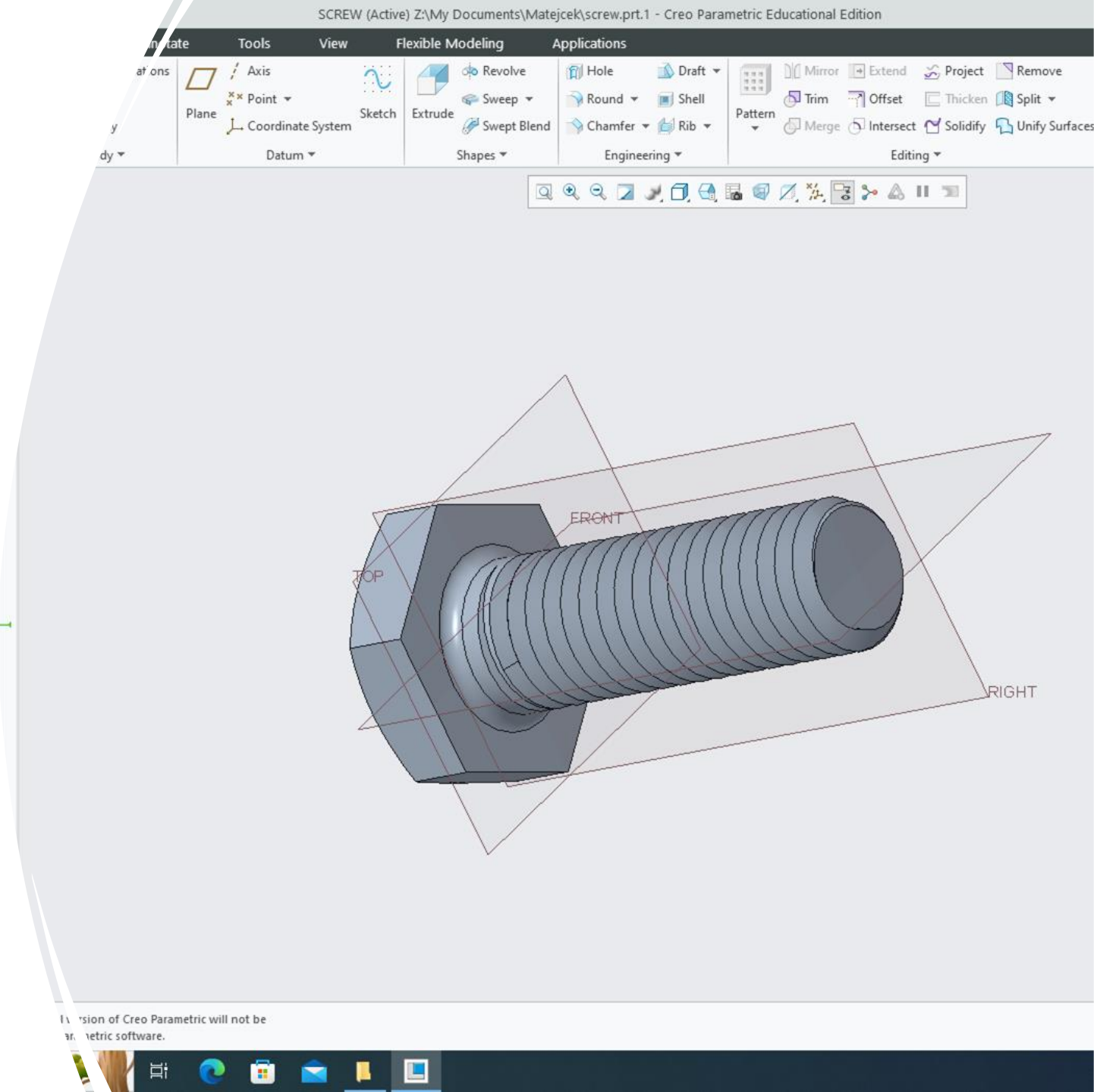

CNC PROGRAMMING AND CAM TECHNOLOGIES

- Mentor: Mr. Blaž Žakelj
- EMCO Sinumerik
- CNC Milling
- CAM technology

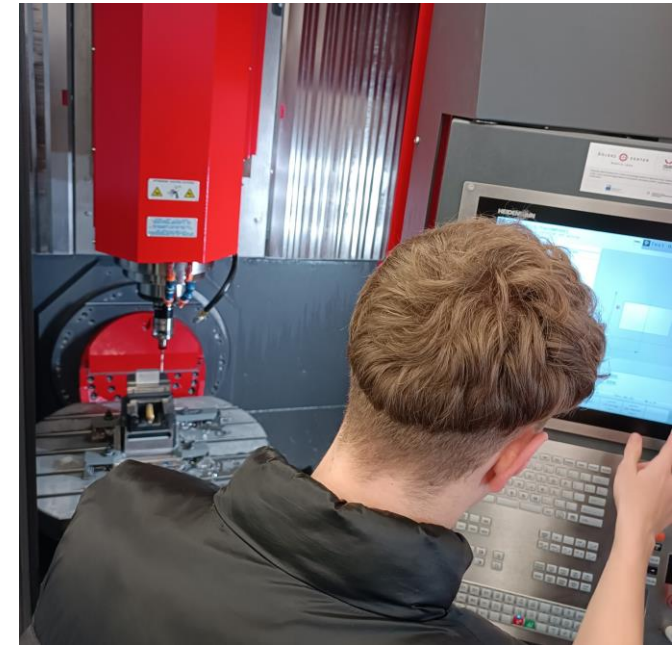

3D PRINTING AND SCANNING

- Mentors: Mr. Matej Praprotnik, Mr. Urban Verbič
- 3D scanner testing
- Face scanning
- 3D printing
- 3DWOX



TRIP TO LTH CASTINGS

19. March 2024.

Founded in 1948, LTH Castings is a producer of die cast car parts (Mercedes, BMW) and many other components for other companies, including Bosch and Continental

We were shown the toolshop, where parts are mass-produced

LTH has production sites in Škofja Loka, Ljubljana, Croatia and North Macedonia



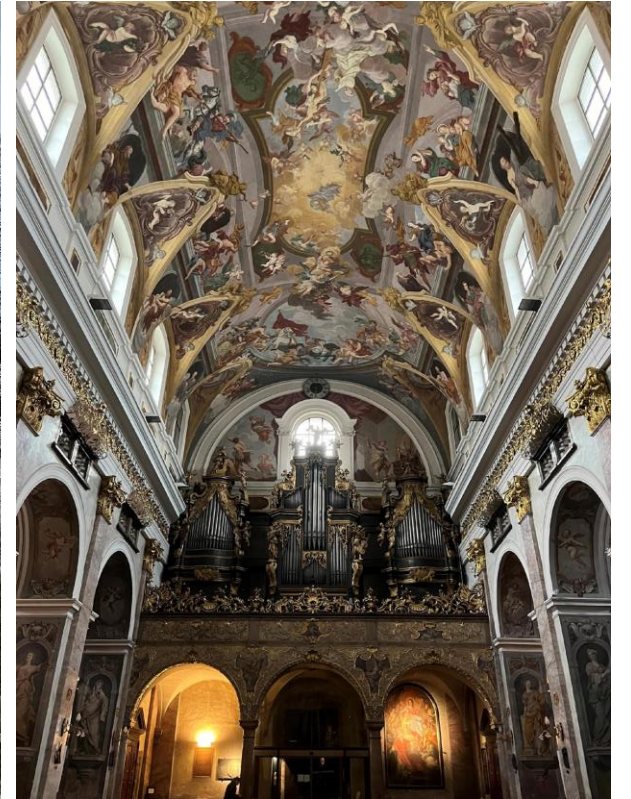

TRAVELLING

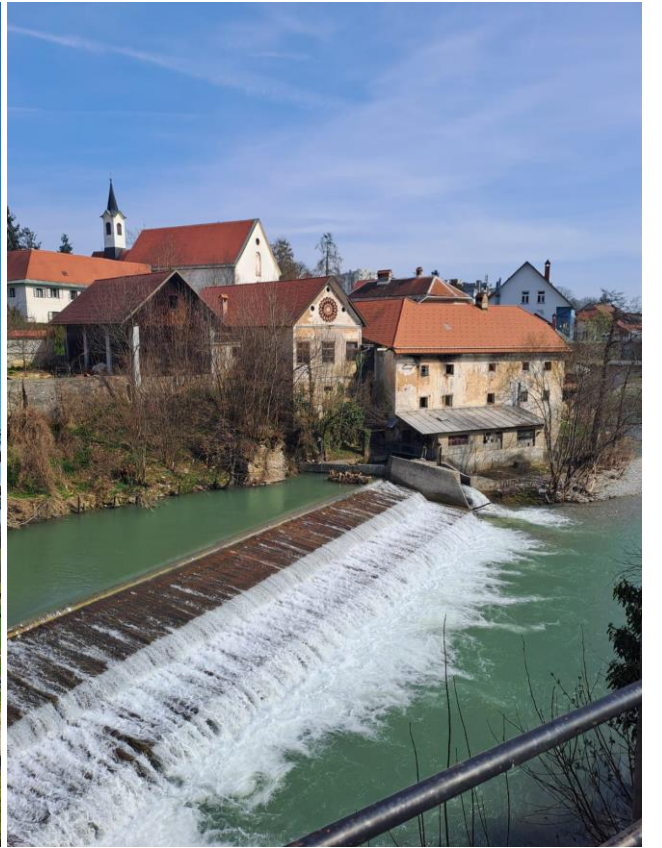
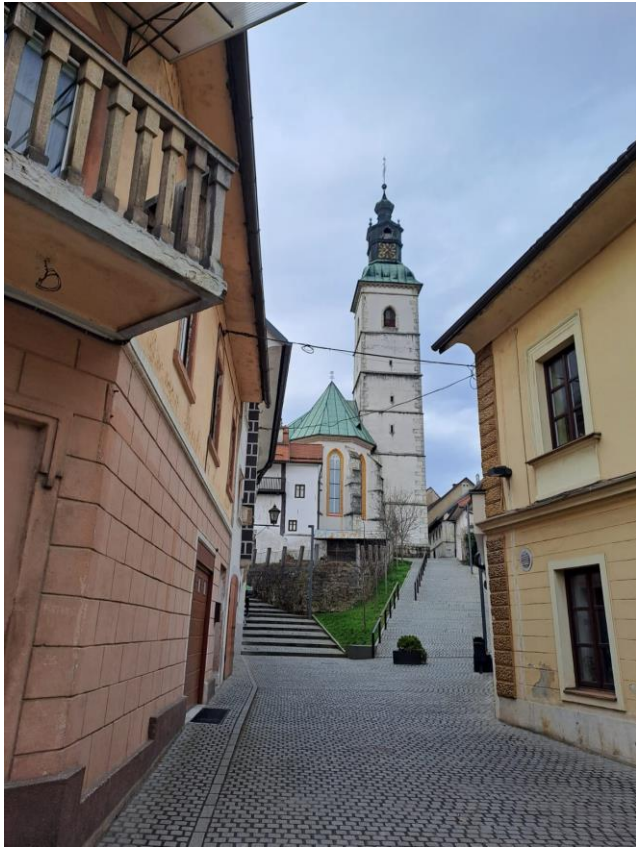

TRAVELLING

SPECIAL THANKS TO

Mr. Tadej Gartner

Mr. Urban Verbič

Mr. Matej Praprotnik

Mr. Matjaž Luznar

Mr. Marko Ahčin

Mr. Blaž Žakelj

Mr. Tomáš Vančura

Mr. Miroslav Candra

Mr. David Studenovský

Mr. Davor Sokač

Mrs. Monika Hodnická



**THANK YOU FOR YOUR
ATTENTION!**